



This catalog is intended to lend a helping hand in the design and use of architectural cast stone building elements. The profiles shown here are by no means the limitations of our capabilities, and will hopefully serve as a guide that can save time in mold fabrication and also money on your project. Stock profiles can be used in a multitude of ways to personalize your project with the permanence and beauty of architectural cast stone.

If you have questions, please call our office to speak with someone today. We offer complete shop drawings and we will assist you from beginning until completion of your job. We are producer members of the Cast Stone Institute and adhere to their standards and practices. We thank you and look forward to hearing from you soon.

Order of Items

Keystones
Springer Blocks
Jackarches
Headers
Address Markers
Quoins
Window Sills
Banding
Wall Coping
Pier Caps
Window and Door Surrounds
Base Course
Signs
Step Treads and Risers
Tuscan Columns
Balustrade
Echo Stone- utility and veneer

CAST STONE SYSTEMS, INC.
532 West Ridgeway Street
Warrenton, North Carolina 27589
252-257-1599 Phone
252-257-1588 FAX
www.caststonesystems.com

Call 888-521-5204 for information.



Modular Keystones

| | |
|------------|---------------------------|
| Item: | 3 course key modular size |
| Part # | KM3 |
| Height: | 7-5/8" |
| Thickness: | 4" |

| | |
|------------|---------------------------|
| Item: | 4 course key modular size |
| Part # | KM4 |
| Height: | 10-1/4" |
| Thickness: | 4" |

| | |
|------------|---------------------------|
| Item: | 5 course key modular size |
| Part # | KM5 |
| Height: | 13" |
| Thickness: | 4" |

| | |
|------------|---------------------------|
| Item: | 6 course key modular size |
| Part # | KM6 |
| Height: | 15-5/8" |
| Thickness: | 4" |

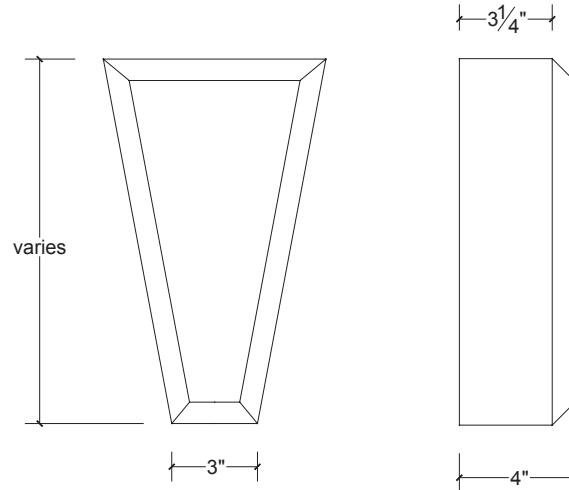

Oversize Keystones

| | |
|------------|-----------------------|
| Item: | 3 course key oversize |
| Part # | KO3 |
| Height: | 9" |
| Thickness: | 4" |

| | |
|------------|-----------------------|
| Item: | 4 course key oversize |
| Part # | KO4 |
| Height: | 12-1/8" |
| Thickness: | 4" |

| | |
|------------|-----------------------|
| Item: | 5 course key oversize |
| Part # | KO5 |
| Height: | 15-1/4" |
| Thickness: | 4" |

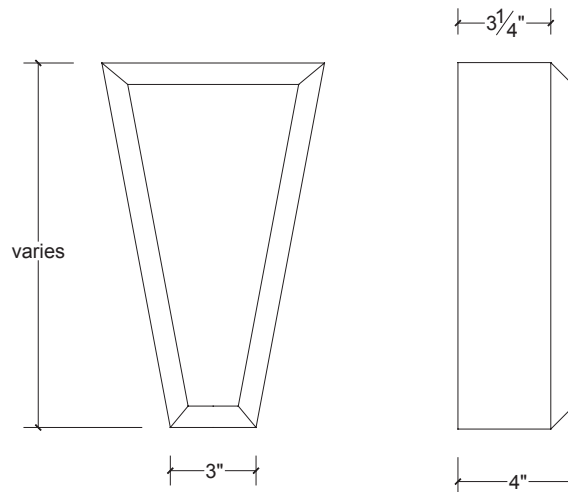



Batwing Keystones

| | |
|------------|---------------------------|
| Item: | 6 Course Batwing Keystone |
| Part # | KB6 |
| Height: | 15" |
| Thickness: | 3-5/8" |

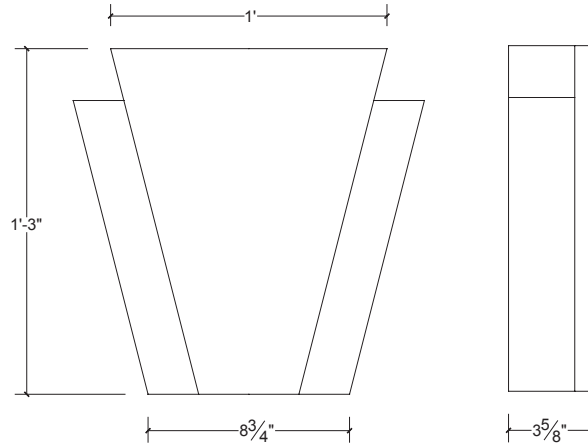

| | |
|------------|-----------------------------------|
| Item: | 4 course batwing key modular size |
| Part # | KBM4 |
| Height: | 10-1/4" |
| Thickness: | 4-3/8" |

| | |
|------------|-----------------------------------|
| Item: | 5 course batwing key modular size |
| Part # | KBM5 |
| Height: | 13" |
| Thickness: | 4-3/8" |

| | |
|------------|-----------------------------------|
| Item: | 6 course batwing key modular size |
| Part # | KBM6 |
| Height: | 15-5/8" |
| Thickness: | 4" |

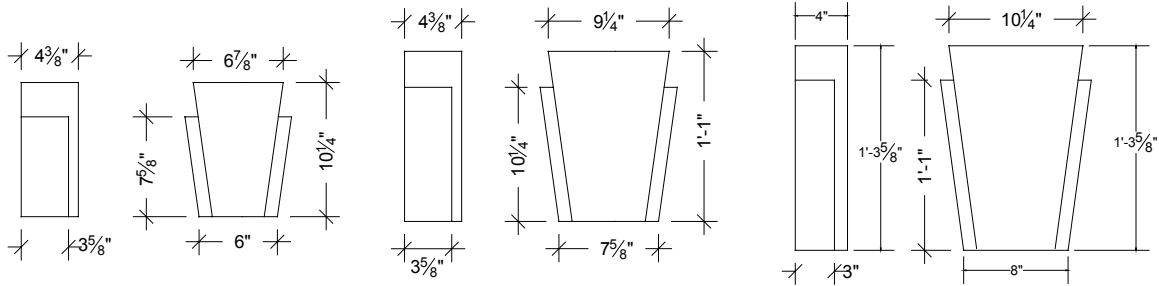

Springers

| | |
|------------|-------------------|
| Item: | Springer 3 course |
| Part # | SPM3 |
| Height: | 7-5/8" |
| Length: | 7-5/8" |
| Thickness: | 4"* see drawing |

| | |
|------------|-------------------|
| Item: | Springer 6 course |
| Part # | SPM6 |
| Height: | 15-5/8" |
| Length: | 15-5/8" |
| Thickness: | 4"* see drawing |

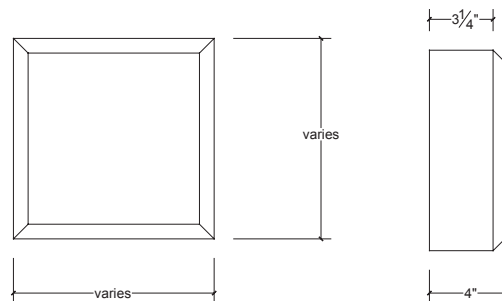



Jack Arch

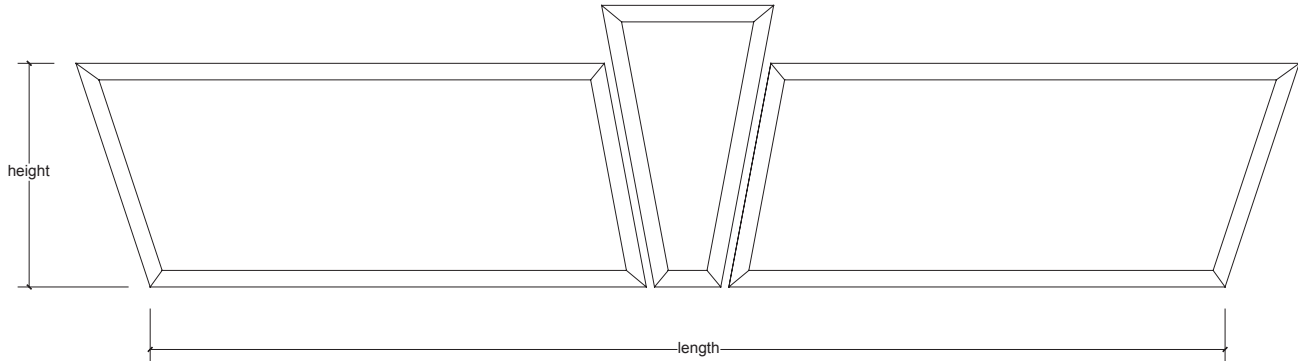

3 1/4"



4"

section

| | |
|------------|--|
| Item: | 4 course modular arch and 5 course key |
| Part # | JAM4 |
| Height: | 10-1/4" |
| Thickness: | 4"* |
| Length: | specify |

| | |
|------------|--|
| Item: | 5 course modular arch and 6 course key |
| Part # | JAM5 |
| Height: | 13" |
| Thickness: | 4"* |
| Length: | specify |

| | |
|------------|---|
| Item: | 4 course oversize arch and 5 course key |
| Part # | JAO4 |
| Height: | 12-1/8" |
| Thickness: | 4"* |
| Length: | specify |

| | |
|------------|---|
| Item: | 5 course oversize arch and 6 course key |
| Part # | JAO5 |
| Height: | 15-1/4" |
| Thickness: | 4"* |
| Length: | specify |

Information.

1. Keystone is included with jackarch set.
2. Establish part number that coincides with brick type and desired course height.
3. Verify Length of opening and allow for brick molding or jambs if applicable. (masonry opening)
4. Shelf angle required.
5. Square profile is available upon request.

Call 888-521-5204 for information.



Angled Headers

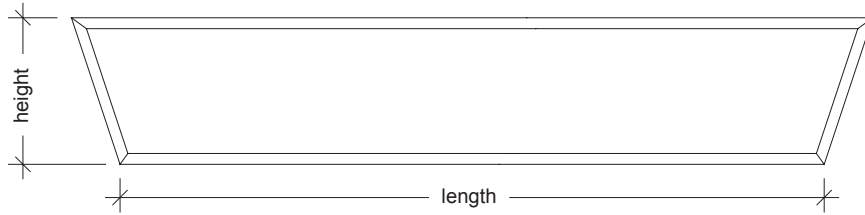

| | |
|------------|--------------------------------|
| Item: | 4 course modular header angled |
| Part # | H1M4 |
| Height: | 10-1/4" |
| Thickness: | 4"* |
| Length: | specify |

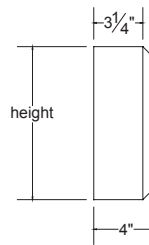

| | |
|------------|---------------------------------|
| Item: | 4 course oversize header angled |
| Part # | H1O4 |
| Height: | 12-1/8" |
| Thickness: | 4"* |
| Length: | specify |

| | |
|------------|--------------------------------|
| Item: | 5 course modular header angled |
| Part # | H1M5 |
| Height: | 13" |
| Thickness: | 4"* |
| Length: | specify |

| | |
|------------|---------------------------------|
| Item: | 5 course oversize header angled |
| Part # | H1O5 |
| Height: | 15-1/4" |
| Thickness: | 4"* |
| Length: | specify |

Rectangular Headers

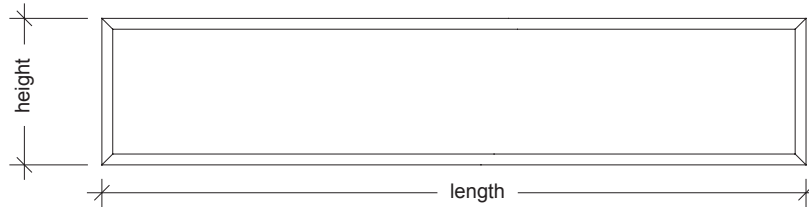

| | |
|------------|-------------------------------------|
| Item: | 4 course modular header rectangular |
| Part # | H2M4 |
| Height: | 10-1/4" |
| Thickness: | 4"* |
| Length: | specify |

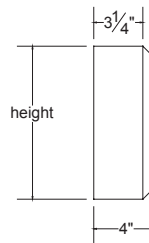

| | |
|------------|--------------------------------------|
| Item: | 4 course oversize header rectangular |
| Part # | H2O4 |
| Height: | 12-1/8" |
| Thickness: | 4"* |
| Length: | specify |

| | |
|------------|-------------------------------------|
| Item: | 5 course modular header rectangular |
| Part # | H2M5 |
| Height: | 13" |
| Thickness: | 4"* |
| Length: | specify |

| | |
|------------|--------------------------------------|
| Item: | 5 course oversize header rectangular |
| Part # | H2O5 |
| Height: | 15-1/4" |
| Thickness: | 4"* |
| Length: | specify |



Address Markers

| | |
|------------|---------------------------------|
| Item: | 3 course modular address marker |
| Part # | AMM3 |
| Height: | 7-5/8" |
| Thickness: | 4" |
| Length: | 15-5/8" |

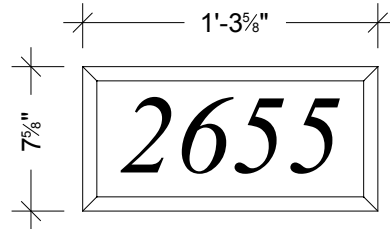

| | |
|------------|---------------------------------|
| Item: | 4 course modular address marker |
| Part # | AMM4 |
| Height: | 10-1/4" |
| Thickness: | 4" |
| Length: | 29-5/8" |

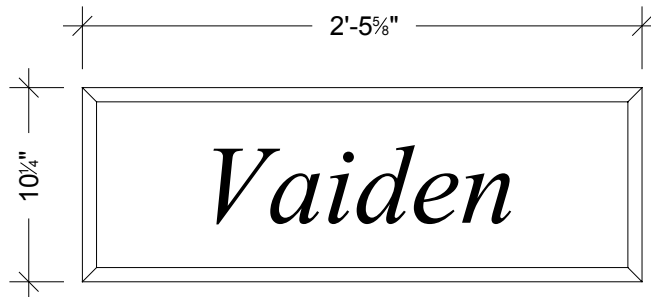

| | |
|------------|----------------------------------|
| Item: | 3 course oversize address marker |
| Part # | AMO3 |
| Height: | 8-5/8" |
| Thickness: | 4" |
| Length: | 23-5/8" |

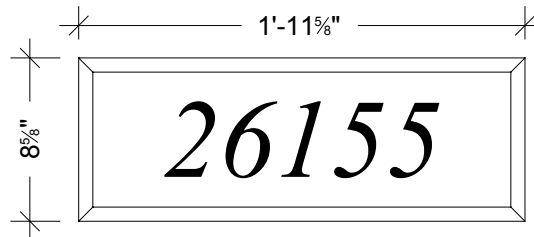

| | |
|------------|----------------------------------|
| Item: | 4 course oversize address marker |
| Part # | AMO4 |
| Height: | 12-1/8" |
| Thickness: | 4" |
| Length: | 23-5/8" |

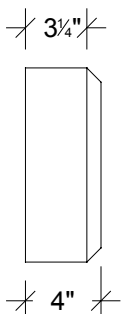
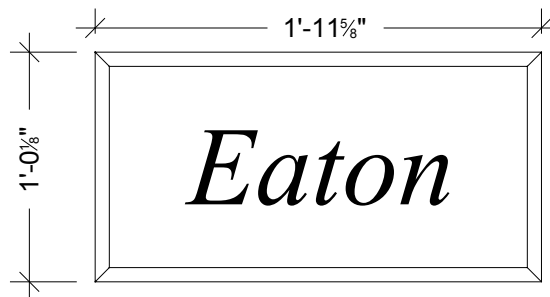

Typical Section

Information

1. Font is Times New Roman (Italicized) Other fonts are available with possible setup charge.
2. Letters are sand blasted and painted black. 6 letters maximum.
3. Letters shown are 4" tall.

Call 888-521-5204 for information.



Quoins

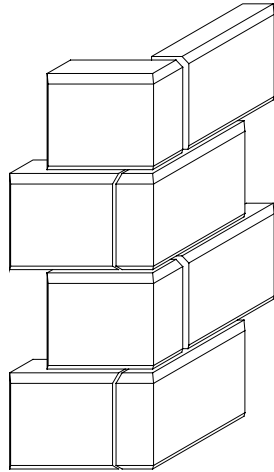

Staggered

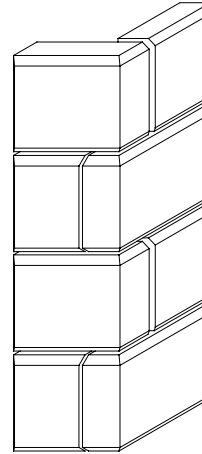

Stacked

| | |
|------------|----------------------------------|
| Item: | Quoin 4 course modular staggered |
| Part # | QM4Z |
| Height: | 10-1/4" |
| Thickness: | 4" |
| Length: | |

| | |
|------------|----------------------------------|
| Item: | Quoin 6 course modular staggered |
| Part # | QM6Z |
| Height: | 15-5/8" |
| Thickness: | 4" |
| Length: | |

| | |
|------------|-----------------------------------|
| Item: | Quoin 4 course oversize staggered |
| Part # | QO4Z |
| Height: | 12-1/8" |
| Thickness: | 4" |
| Length: | |

| | |
|------------|-----------------------------------|
| Item: | Quoin 5 course oversize staggered |
| Part # | QO5Z |
| Height: | 15-1/4" |
| Thickness: | 4" |
| Length: | |

| | |
|------------|--------------------------------|
| Item: | Quoin 4 course modular stacked |
| Part # | QM4 |
| Height: | 10-1/4" |
| Thickness: | 4" |
| Length: | 12" |

| | |
|------------|--------------------------------|
| Item: | Quoin 6 course modular stacked |
| Part # | QM6 |
| Height: | 15-5/8" |
| Thickness: | 4" |
| Length: | 16" |

| | |
|------------|---------------------------------|
| Item: | Quoin 4 course oversize stacked |
| Part # | QO4 |
| Height: | 12-1/8" |
| Thickness: | 4" |
| Length: | |

| | |
|------------|---------------------------------|
| Item: | Quoin 5 course oversize stacked |
| Part # | QO5 |
| Height: | 15-1/4" |
| Thickness: | 4" |
| Length: | |



Window Sills

| | |
|------------|----------------------|
| Item: | Window Sill bullnose |
| Part # | S1 |
| Height: | 3-1/2" |
| Thickness: | 5"* |
| Length: | 47-5/8" cut to fit. |

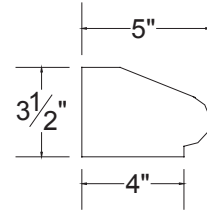

| | |
|------------|---------------------------|
| Item: | Window Sill ogee bullnose |
| Part # | S2 |
| Height: | 5" |
| Thickness: | 6-3/4"* |
| Length: | 47-5/8" cut to fit. |

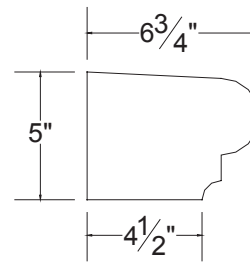

| | |
|------------|---------------------|
| Item: | Window Sill |
| Part # | S3 |
| Height: | 5" |
| Thickness: | 5"* |
| Length: | 47-5/8" cut to fit. |

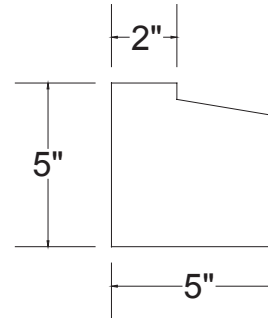

| | |
|------------|---------------------|
| Item: | Window Sill |
| Part # | S4 |
| Height: | 3-5/8" |
| Thickness: | 5" |
| Length: | 47-5/8" cut to fit. |

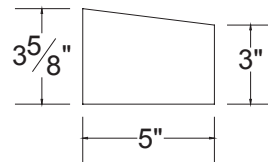

| | |
|------------|---------------------|
| Item: | Window Sill |
| Part # | S5 |
| Height: | 5" |
| Thickness: | 7-5/8" |
| Length: | 47-5/8" cut to fit. |

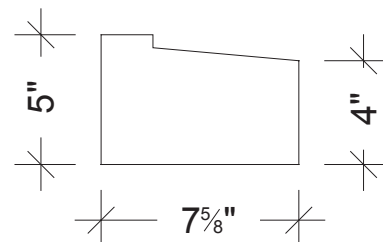



Banding

| | | |
|------------|---------------|---------|
| Item: | Eaton Banding | |
| Part # | B1E4 | B1E5 |
| Height: | 7-5/8" | 10-1/4" |
| Thickness: | 4"* | 4"* |
| Length: | 35-5/8" | 35-5/8" |

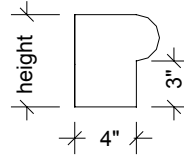

| | | |
|------------|----------------|---------|
| Item: | Shocco Banding | |
| Part # | B2S4 | B2S5 |
| Height: | 7-5/8" | 10-1/4" |
| Thickness: | 4"* | 4"* |
| Length: | 35-5/8" | 35-5/8" |

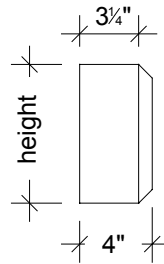

| | | |
|------------|--------------|--|
| Item: | Polk Banding | |
| Part # | B3P2 | |
| Height: | 3-5/8" | |
| Thickness: | 4-3/8"* | |
| Length: | 35-5/8" | |

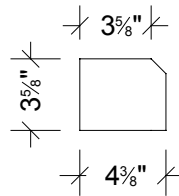

| | | | |
|------------|----------------|---------|---------|
| Item: | Vaiden Banding | | |
| Part # | B4V5 | B4V6 | B4V6 |
| Height: | 7-5/8" | 10-1/4" | 15-5/8" |
| Thickness: | 3-5/8"* | 3-5/8"* | 3-5/8"* |
| Length: | 35-5/8" | 35-5/8" | 35-5/8" |

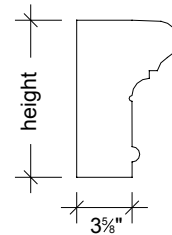

| | | |
|------------|----------------|--|
| Item: | Saxham Banding | |
| Part # | B5S4 | |
| Height: | 6" | |
| Thickness: | 7-1/2"* | |
| Length: | 35-5/8" | |

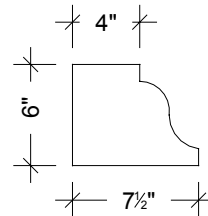

| | | | |
|------------|--------------|---------|---------|
| Item: | Jane Banding | | |
| Part # | B6S4 | B6S5 | B6S6 |
| Height: | 7-5/8" | 10-1/4" | 15-5/8" |
| Thickness: | 3-5/8" | 3-5/8" | 3-5/8" |
| Length: | 35-5/8" | 35-5/8" | 35-5/8" |

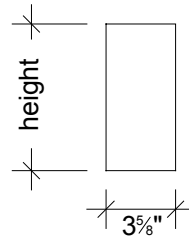

For returns add L for Left conditions and R for right conditions to the end of corresponding part numbers.



Wall Cap

| Item: | Center Peak Wall Cap | | | | | | |
|---------|----------------------|---------|---------|---------|---------|---------|---------|
| Part # | WC112 | WC114 | WC116 | WC118 | WC120 | WC122 | WC124 |
| Height: | 4" | 4" | 4" | 4" | 4" | 4" | 4" |
| Width: | 12" | 14" | 16" | 18" | 20" | 22" | 24" |
| Length: | 35-5/8" | 35-5/8" | 35-5/8" | 35-5/8" | 35-5/8" | 35-5/8" | 35-5/8" |

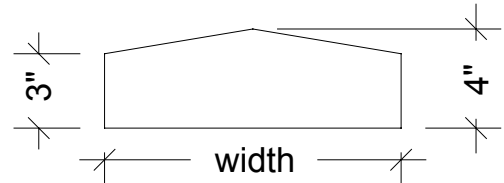

| Item: | Sloped Wall Cap | | | | | | |
|---------|-----------------|---------|---------|---------|---------|---------|---------|
| Part # | WC212 | WC214 | WC216 | WC218 | WC220 | WC222 | WC224 |
| Height: | 4" | 4" | 4" | 4" | 4" | 4" | 4" |
| Width: | 12" | 14" | 16" | 18" | 20" | 22" | 24" |
| Length: | 35-5/8" | 35-5/8" | 35-5/8" | 35-5/8" | 35-5/8" | 35-5/8" | 35-5/8" |

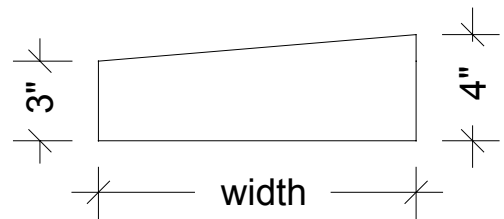

| Item: | Bullnose Wall Cap | | | | | | |
|---------|-------------------|---------|---------|---------|---------|---------|---------|
| Part # | WC312 | WC314 | WC316 | WC318 | WC320 | WC322 | WC324 |
| Height: | 4" | 4" | 4" | 4" | 4" | 4" | 4" |
| Width: | 12" | 14" | 16" | 18" | 20" | 22" | 24" |
| Length: | 35-5/8" | 35-5/8" | 35-5/8" | 35-5/8" | 35-5/8" | 35-5/8" | 35-5/8" |

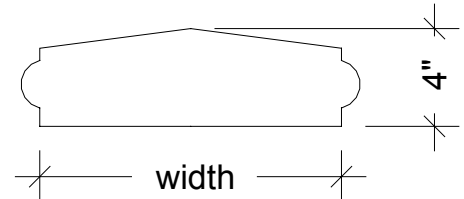

| Item: | Crown Wall Cap | | | | | | |
|---------|----------------|---------|---------|---------|---------|---------|---------|
| Part # | WC412 | WC414 | WC416 | WC418 | WC420 | WC422 | WC424 |
| Height: | 4" | 4" | 4" | 4" | 4" | 4" | 4" |
| Width: | 12" | 14" | 16" | 18" | 20" | 22" | 24" |
| Length: | 35-5/8" | 35-5/8" | 35-5/8" | 35-5/8" | 35-5/8" | 35-5/8" | 35-5/8" |

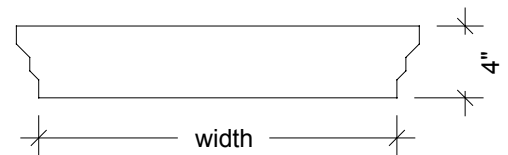

Helpful Tips.

1. For corners or returns add L for Left conditions and R for right conditions to the end of corresponding part numbers.
2. For finished end conditions add FE to the end of the corresponding part numbers.
3. For Radius conditions add R to corresponding part numbers and include radius to inside of the wall. Additional charges apply.



Pier Caps

| | | | | | | | | |
|---------|----------------|--------|--------|--------|--------|--------|--------|--------|
| Item: | Elgin Pier Cap | | | | | | | |
| Part # | PC2E16 | PC2E18 | PC2E20 | PC2E22 | PC2E24 | PC2E26 | PC2E28 | PC2E30 |
| Height: | | | | | | | | |
| Width: | 16" | 18" | 20" | 22" | 24" | 26" | 28" | 30" |
| Length: | 16" | 18" | 20" | 22" | 24" | 26" | 28" | 30" |

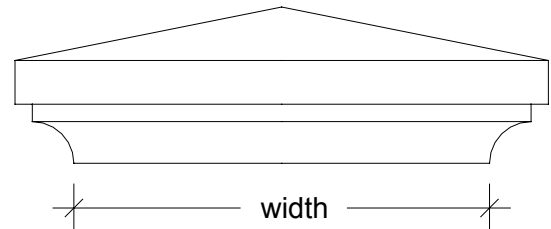

| | | | | | | | | | |
|---------|-------------------|--------|--------|--------|--------|--------|--------|--------|--------|
| Item: | Nebraska Pier Cap | | | | | | | | |
| Part # | PC5N16 | PC5N18 | PC5N20 | PC5N22 | PC5N24 | PC5N26 | PC5N28 | PC5N30 | PC5N36 |
| Height: | | | | | | | | | |
| Width: | 16" | 18" | 20" | 22" | 24" | 26" | 28" | 30" | 36" |
| Length: | 16" | 18" | 20" | 22" | 24" | 26" | 28" | 30" | 36" |

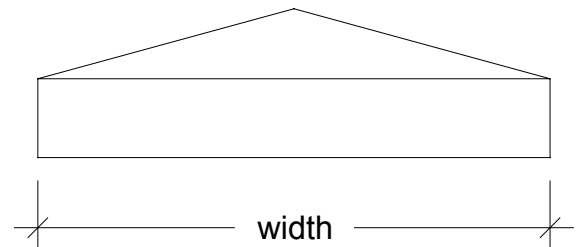

| | | | | | | | | | |
|---------|-----------------|--------|--------|--------|--------|--------|--------|--------|--------|
| Item: | Buxton Pier Cap | | | | | | | | |
| Part # | PC4B16 | PC4B18 | PC4B20 | PC4B22 | PC4B24 | PC4B26 | PC4B28 | PC4B30 | PC4B36 |
| Height: | 6" | 6" | 6" | 6" | 7" | 7" | 7" | 7" | 7" |
| Width: | 16" | 18" | 20" | 22" | 24" | 26" | 28" | 30" | 36" |
| Length: | 16" | 18" | 20" | 22" | 24" | 26" | 28" | 30" | 36" |

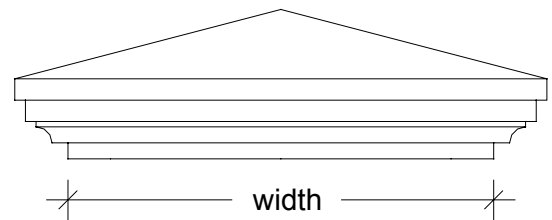



Pier Caps

Item: Montmorenci Pier Cap

| | | | | | | | | |
|---------|--------|--------|--------|--------|--------|--------|--------|--------|
| Part # | PC2E16 | PC2E18 | PC2E20 | PC2E22 | PC2E24 | PC2E26 | PC2E28 | PC2E30 |
| Height: | | | | | | | | |
| Width: | 16" | 18" | 20" | 22" | 24" | 26" | 28" | 30" |
| Length: | 16" | 18" | 20" | 22" | 24" | 26" | 28" | 30" |

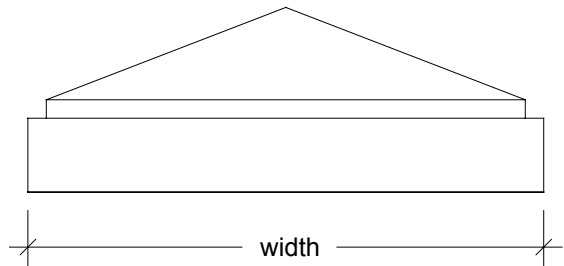

Item: Tusculum Pier Cap

| | | | | | | |
|---------|--------|--------|--------|--------|--------|--------|
| Part # | PC6T20 | PC6T22 | PC6T24 | PC6T26 | PC6T28 | PC6T30 |
| Height: | 5-1/2" | 5-1/2" | 5-1/2" | 5-1/2" | 5-1/2" | 5-1/2" |
| Width: | 20" | 22" | 24" | 26" | 28" | 30" |
| Length: | 20" | 22" | 24" | 26" | 28" | 30" |

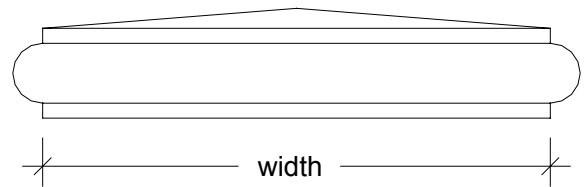

Item: Tarwater Pier Cap

| | | |
|---------|--------|--------|
| Part # | PC1T24 | PC1T28 |
| Height: | " | " |
| Width: | 24"* | 24"* |
| Length: | 24"* | 24"* |

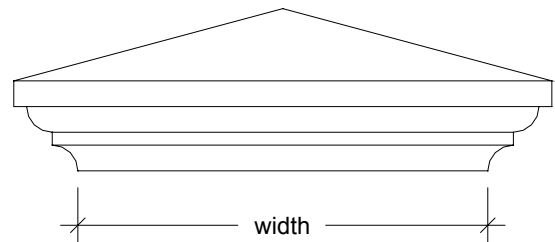



Window and Door Surrounds

| | | | | |
|------------|-----------------------------|---------|---------|---------|
| Item: | Rectangular Window Surround | | | |
| Part # | SU1S | SU1X | SU1BS | SU1BX |
| Height: | 7-5/8" | 7-5/8" | 15-5/8" | 15-5/8" |
| Thickness: | 3-5/8" | 3-5/8" | 3-5/8" | 3-5/8" |
| Length: | 35-5/8" | 47-5/8" | 35-5/8" | 47-5/8" |

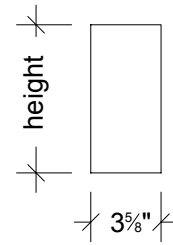

| | | | |
|-------------|---------------------------|-------------|--------------|
| Item: | Chamfered Window Surround | | |
| Part # | SU2S | SU2L | SU2R |
| Height: | 7-5/8" | 7-5/8" | 7-5/8" |
| Thickness: | 3-5/8" | 3-5/8" | 3-5/8" |
| Length: | 35-5/8" | 35-5/8" | 35-5/8" |
| Description | Straight | Left Return | Right Return |

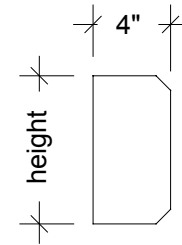

| | | | |
|-------------|-------------------------|-------------|--------------|
| Item: | Chamfered Door Surround | | |
| Part # | SU2XS | SU2XL | SU2XR |
| Height: | 15-5/8" | 15-5/8" | 15-5/8" |
| Thickness: | 4"* | 4"* | 4"* |
| Length: | 47-5/8" | 47-5/8" | 47-5/8" |
| Description | Straight | Left Return | Right Return |

| | | | |
|-------------|---------------------------|-------------|--------------|
| Item: | Anchorage Window Surround | | |
| Part # | SU3S | SU3L | SU3R |
| Height: | 7-5/8" | 7-5/8" | 7-5/8" |
| Thickness: | 4-3/8"* | 4-3/8"* | 4-3/8"* |
| Length: | 35-5/8" | 35-5/8" | 35-5/8" |
| Description | Straight | Left Return | Right Return |

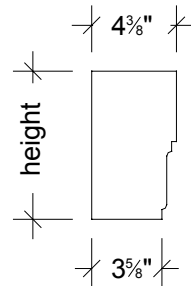

| | | | |
|-------------|-------------------------|-------------|--------------|
| Item: | Anchorage Door Surround | | |
| Part # | SU3XS | SU3XL | SU3XR |
| Height: | 15-5/8" | 15-5/8" | 15-5/8" |
| Thickness: | 4-3/8"* | 4-3/8"* | 4-3/8"* |
| Length: | 47-5/8" | 47-5/8" | 47-5/8" |
| Description | Straight | Left Return | Right Return |

| | | | |
|-------------|---------------------------|-------------|--------------|
| Item: | Arrington Window Surround | | |
| Part # | SU2S | SU2L | SU2R |
| Height: | 7-5/8" | 7-5/8" | 7-5/8" |
| Thickness: | 3-5/8" | 3-5/8" | 3-5/8" |
| Length: | 35-5/8" | 35-5/8" | 35-5/8" |
| Description | Straight | Left Return | Right Return |

| | | | |
|-------------|-------------------------|-------------|--------------|
| Item: | Arrington Door Surround | | |
| Part # | SU2XS | SU2XL | SU2XR |
| Height: | 15-5/8" | 15-5/8" | 15-5/8" |
| Thickness: | 4"* | 4"* | 4"* |
| Length: | 47-5/8" | 47-5/8" | 47-5/8" |
| Description | Straight | Left Return | Right Return |

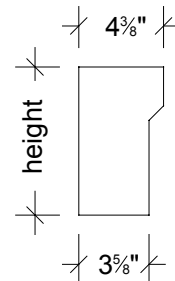



| Item: | Base Course Chamfer | | |
|-------------|---------------------|-------------|--------------|
| Part # | BC1S | BC1L | BC1R |
| Height: | 15-5/8" | 15-5/8" | 15-5/8" |
| Thickness: | 4-3/8" | 4-3/8" | 4-3/8" |
| Length: | 35-5/8" | 35-5/8" | 35-5/8" |
| Description | Straight | Left Return | Right Return |

| Item: | Base Course Chamfer | | |
|-------------|---------------------|-------------|--------------|
| Part # | BC1XS | BC1XL | BC1XR |
| Height: | 23-5/8" | 23-5/8" | 23-5/8" |
| Thickness: | 4-3/8" | 4-3/8" | 4-3/8" |
| Length: | 35-5/8" | 35-5/8" | 35-5/8" |
| Description | Straight | Left Return | Right Return |

Base Course

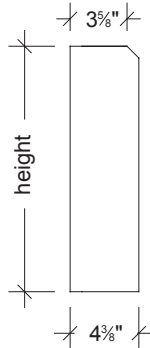

| Item: | Base Course Jane | | |
|-------------|------------------|-------------|--------------|
| Part # | BC2S | BC2L | BC2R |
| Height: | 15-5/8" | 15-5/8" | 15-5/8" |
| Thickness: | 3-5/8" | 3-5/8" | 3-5/8" |
| Length: | 35-5/8" | 35-5/8" | 35-5/8" |
| Description | Straight | Left Return | Right Return |

| Item: | Base Course Jane | | |
|-------------|------------------|-------------|--------------|
| Part # | BC2XS | BC2XL | BC2XR |
| Height: | 23-5/8" | 23-5/8" | 23-5/8" |
| Thickness: | 3-5/8" | 3-5/8" | 3-5/8" |
| Length: | 35-5/8" | 35-5/8" | 35-5/8" |
| Description | Straight | Left Return | Right Return |

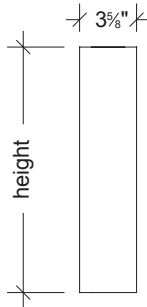

| Item: | Base Course Mount Petros | | |
|-------------|--------------------------|-------------|--------------|
| Part # | BC5S | BC5L | BC5R |
| Height: | 15-5/8" | 15-5/8" | 15-5/8" |
| Thickness: | 5" | 5" | 5" |
| Length: | 35-5/8" | 35-5/8" | 35-5/8" |
| Description | Straight | Left Return | Right Return |

| Item: | Base Course Mount Petros | | |
|-------------|--------------------------|-------------|--------------|
| Part # | BC5XS | BC5XL | BC5XR |
| Height: | 23-5/8" | 23-5/8" | 23-5/8" |
| Thickness: | 5" | 5" | 5" |
| Length: | 35-5/8" | 35-5/8" | 35-5/8" |
| Description | Straight | Left Return | Right Return |

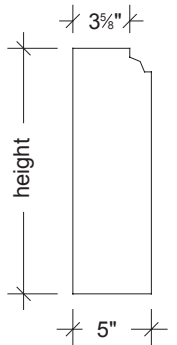

| Item: | Base Course Anchorage | | |
|-------------|-----------------------|-------------|--------------|
| Part # | BC3S | BC3L | BC3R |
| Height: | 15-5/8" | 15-5/8" | 15-5/8" |
| Thickness: | 4-3/8" | 4-3/8" | 4-3/8" |
| Length: | 35-5/8" | 35-5/8" | 35-5/8" |
| Description | Straight | Left Return | Right Return |

| Item: | Base Course Anchorage | | |
|-------------|-----------------------|-------------|--------------|
| Part # | BC3XS | BC3XL | BC3XR |
| Height: | 23-5/8" | 23-5/8" | 23-5/8" |
| Thickness: | 4-3/8" | 4-3/8" | 4-3/8" |
| Length: | 35-5/8" | 35-5/8" | 35-5/8" |
| Description | Straight | Left Return | Right Return |

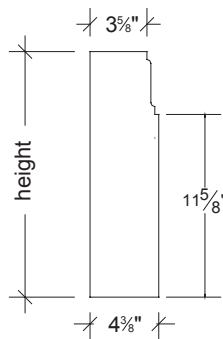

| Item: | Base Course Bullnose | | |
|-------------|----------------------|-------------|--------------|
| Part # | BC4S | BC4L | BC4R |
| Height: | 15-5/8" | 15-5/8" | 15-5/8" |
| Thickness: | 3-5/8" | 3-5/8" | 3-5/8" |
| Length: | 35-5/8" | 35-5/8" | 35-5/8" |
| Description | Straight | Left Return | Right Return |

| Item: | Base Course Bullnose | | |
|-------------|----------------------|-------------|--------------|
| Part # | BC4XS | BC4XL | BC4XR |
| Height: | 23-5/8" | 23-5/8" | 23-5/8" |
| Thickness: | 3-5/8" | 3-5/8" | 3-5/8" |
| Length: | 35-5/8" | 35-5/8" | 35-5/8" |
| Description | Straight | Left Return | Right Return |

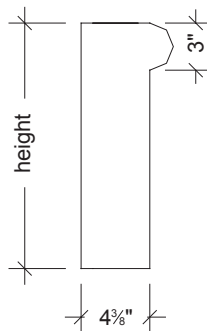



Cast Stone Signs

| | |
|------------|------------|
| Item: | Sign Panel |
| Part # | SSR1 |
| Height: | 30" |
| Length: | 48" |
| Thickness: | 4" |

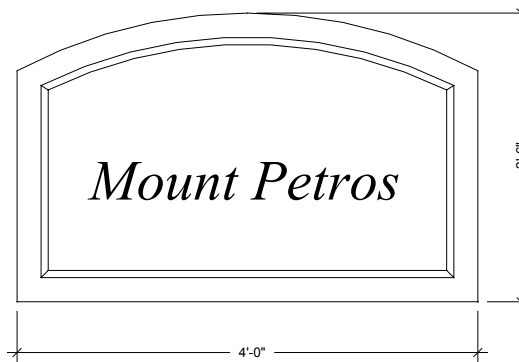

| | |
|------------|------------|
| Item: | Sign Panel |
| Part # | SSR2 |
| Height: | 36"* |
| Length: | 72" |
| Thickness: | 5" |

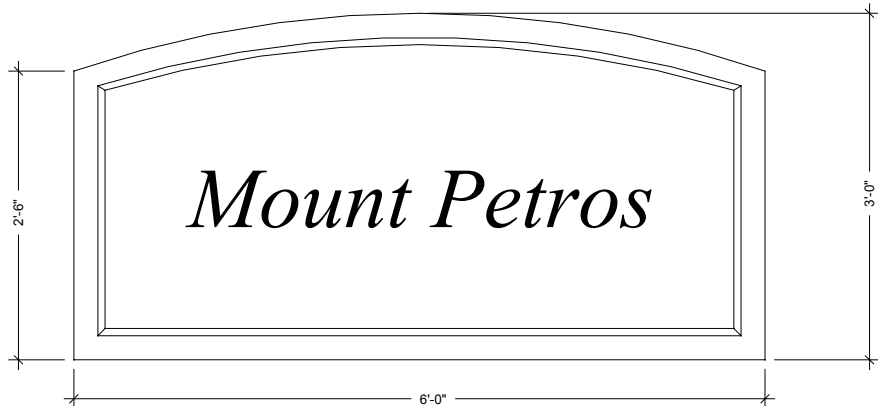

| | |
|------------|------------|
| Item: | Sign Panel |
| Part # | SSR3 |
| Height: | 36" |
| Length: | 96" |
| Thickness: | 5" |





Cast Stone Signs

| | |
|------------|------------|
| Item: | Sign Panel |
| Part # | SS1 |
| Height: | 30" |
| Length: | 48" |
| Thickness: | 4"* |

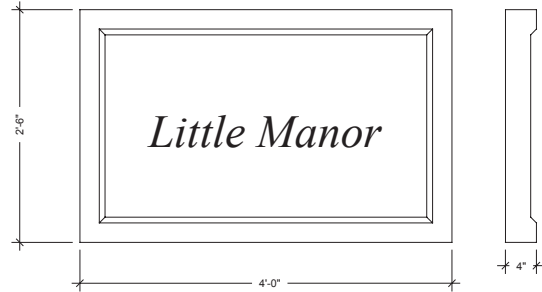

| | |
|------------|------------|
| Item: | Sign Panel |
| Part # | SS2 |
| Height: | 36" |
| Length: | 60" |
| Thickness: | 4-9/16"* |



| | |
|------------|------------|
| Item: | Sign Panel |
| Part # | SS3 |
| Height: | 42" |
| Length: | 72" |
| Thickness: | 5"* |



| | |
|------------|------------|
| Item: | Sign Panel |
| Part # | SS4 |
| Height: | 42" |
| Length: | 96" |
| Thickness: | 5"* |





Step Treads

| | | | |
|--------------|---------------------|-------------|--------------|
| Item: | Bullnose Step Tread | | |
| Part # | TR1 | TR1L | TR1R |
| Height: | 2-1/4" | 2-1/4" | 2-1/4" |
| Width: | 12"* | 12"* | 12"* |
| Length: | 35-5/8" | 35-5/8" | 35-5/8" |
| Description: | Straight | Left Return | Right Return |

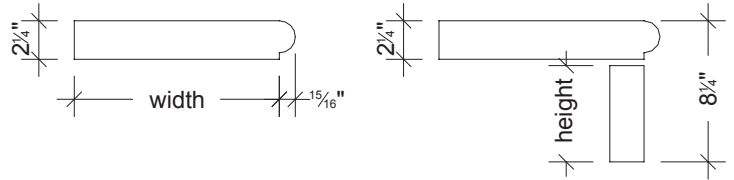

| | |
|------------|---------|
| Item: | Riser |
| Part # | R1 |
| Height: | 7-5/8" |
| Thickness: | 2" |
| Length: | 35-5/8" |

For other widths please call for pricing.

| | | | |
|--------------|---------------------|-------------|--------------|
| Item: | Bullnose Step Tread | | |
| Part # | TR2 | TR2L | TR2R |
| Height: | 2-1/4" | 2-1/4" | 2-1/4" |
| Width: | 12"* | 12"* | 12"* |
| Length: | 35-5/8" | 35-5/8" | 35-5/8" |
| Description: | Straight | Left Return | Right Return |

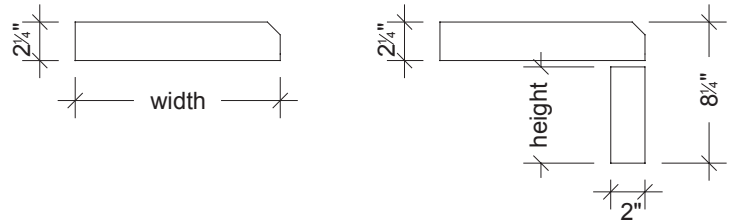

| | |
|------------|---------|
| Item: | Riser |
| Part # | R1 |
| Height: | 7-5/8" |
| Thickness: | 2" |
| Length: | 35-5/8" |

| | | | |
|--------------|--------------------------|-------------|--------------|
| Item: | Ogee Bullnose Step Tread | | |
| Part # | TR3 | TR3L | TR3R |
| Height: | 2-5/8" | 2-5/8" | 2-5/8" |
| Width: | 12"* | 12"* | 12"* |
| Length: | 35-5/8" | 35-5/8" | 35-5/8" |
| Description: | Straight | Left Return | Right Return |

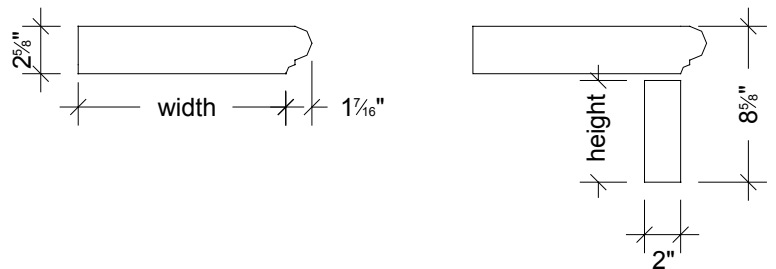

| | |
|------------|---------|
| Item: | Riser |
| Part # | R1 |
| Height: | 7-5/8" |
| Thickness: | 2" |
| Length: | 35-5/8" |



Columns

| | |
|-----------|--------------------------------------|
| Item: | 8' Tuscan Column w/ entasis complete |
| Part # | CT8 |
| Height: | 17' |
| Diameter: | 18" |

| | |
|---------|----------------------|
| Item: | 8' Tuscan Column Cap |
| Part # | CT8C |
| Height: | 5-7/8" |
| Width: | 12-3/4"* |

| | |
|---------|-----------------------|
| Item: | 8' Tuscan Column Base |
| Part # | CT8B |
| Height: | 5-1/4" |
| Width: | 14-3/8"* |

| | |
|-----------|---------------------------------------|
| Item: | 10' Tuscan Column w/ entasis complete |
| Part # | CT10 |
| Height: | 17' |
| Diameter: | 18" |

| | |
|---------|-----------------------|
| Item: | 10' Tuscan Column Cap |
| Part # | CT10C |
| Height: | 7-1/4" |
| Width: | 15-7/8"* |

| | |
|---------|------------------------|
| Item: | 10' Tuscan Column Base |
| Part # | CT10B |
| Height: | 6-5/8" |
| Width: | 18"* |

| | |
|-----------|---------------------------------------|
| Item: | 12' Tuscan Column w/ entasis complete |
| Part # | CT12 |
| Height: | 12' |
| Diameter: | 18" |

| | |
|---------|-----------------------|
| Item: | 12' Tuscan Column Cap |
| Part # | CT12C |
| Height: | 8-3/4" |
| Width: | 19-1/4"* |

| | |
|---------|------------------------|
| Item: | 12' Tuscan Column Base |
| Part # | CT12B |
| Height: | 7-7/8" |
| Width: | 21-1/2"* |

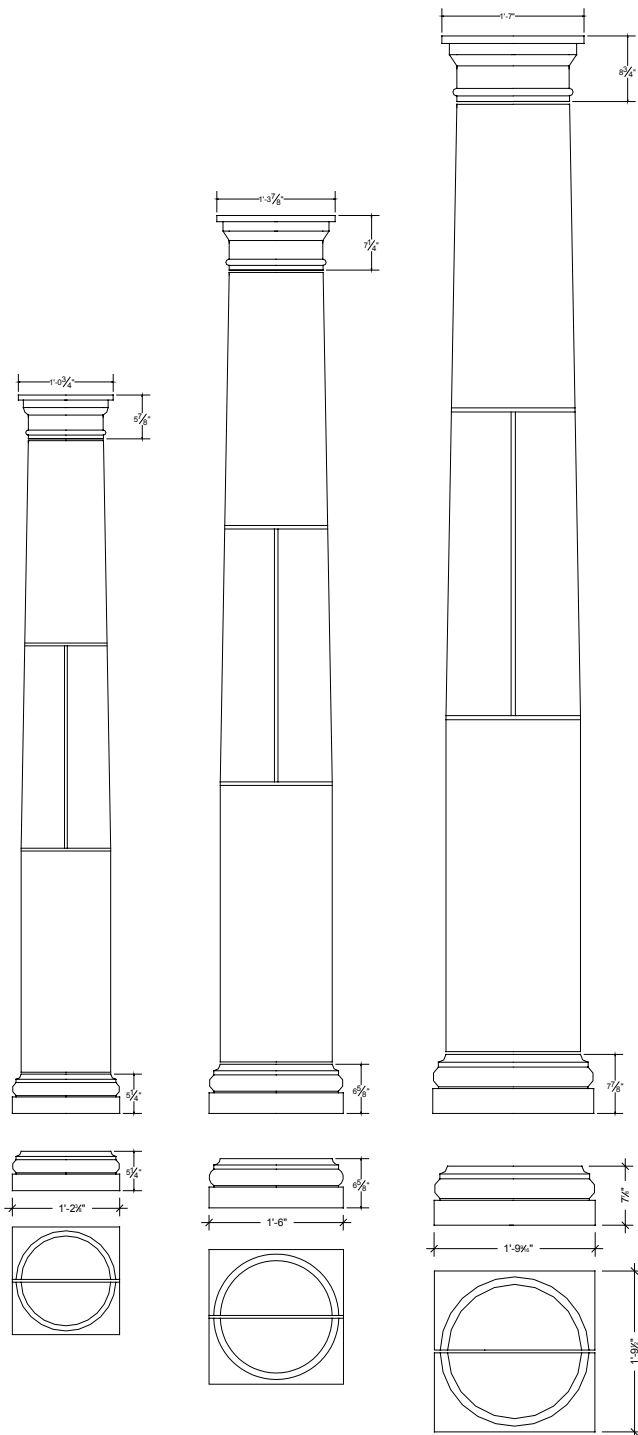

Call 888-521-5204 for information.



Columns

| | |
|------------|---------------------------------------|
| Item: | 17' Tuscan Column w/ entasis complete |
| Part # | CT17 |
| Height: | 17' |
| Diameter: | 18" |
| Thickness: | 4" |

| | |
|---------|-----------------------|
| Item: | 17' Tuscan Column Cap |
| Part # | CT17C |
| Height: | 8-3/4" |
| Width: | 19-1/4" |

| | |
|---------|------------------------|
| Item: | 17' Tuscan Column Base |
| Part # | CT17B |
| Height: | 7-7/8" |
| Width: | 21-1/2" |

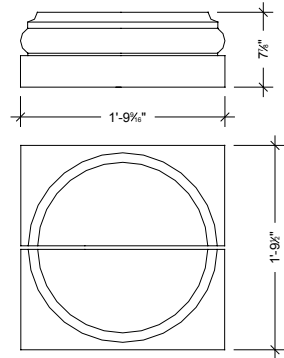
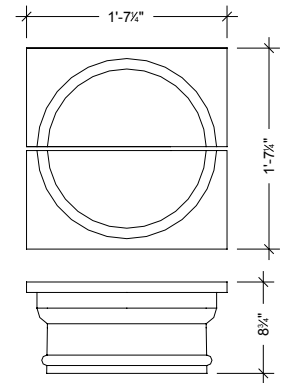
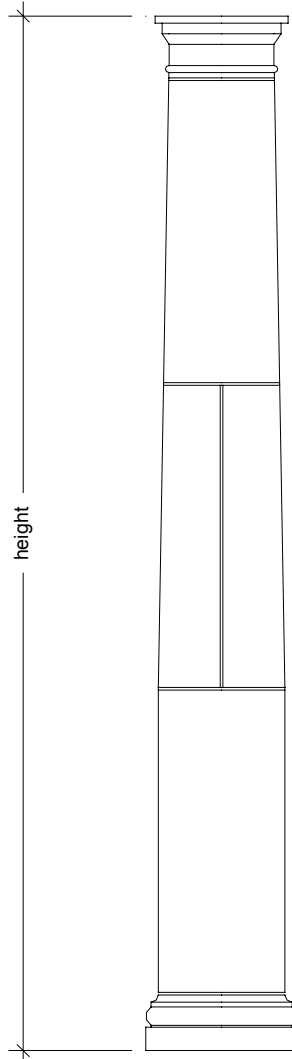

Information.

1. Columns are fabricated in halves and sections.
2. Pieces can be fabricated with recess middle to wrap steel column for load bearing areas.
3. Parts are manufactured with slots for strap attachment as well as holes to accept dowels.
4. Other style columns are quoted on request.
5. Some adjustment in height is possible.

Call 888-521-5204 for information.



Balustrade

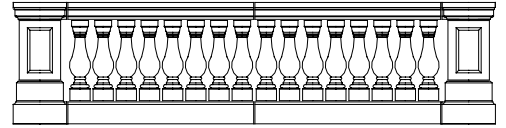
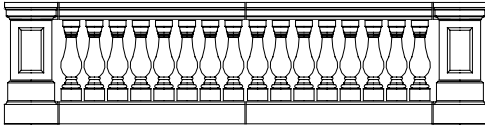

| | |
|---------|-------------------------|
| Item: | Fontena Balustrade Rail |
| Part # | BL1R |
| Height: | 5" |
| Width: | 8-3/4" |
| Length: | 55-1/8" |

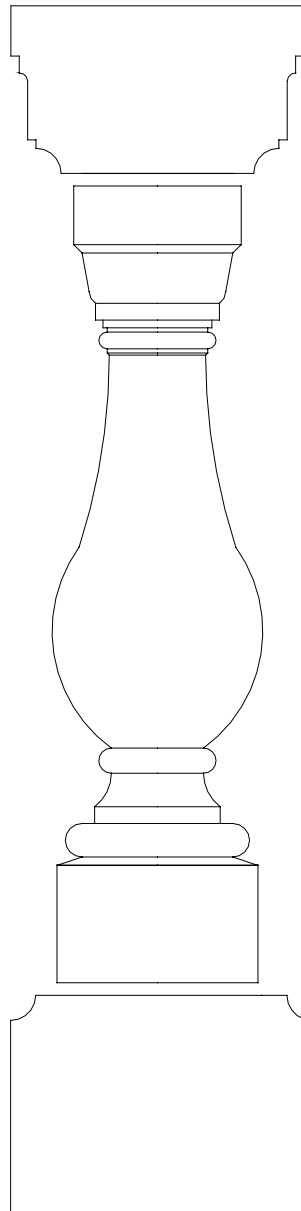

| | |
|---------|--------------------|
| Item: | Fontena Balustrade |
| Part # | BLF |
| Height: | 23-5/8" |
| Width: | 5-1/2" |

| | |
|---------|-------------------------|
| Item: | Fontena Balustrade Base |
| Part # | BL1B |
| Height: | 6-1/2" |
| Width: | 9" |
| Length: | 55-1/8" |

36" Fontena Balustrade System

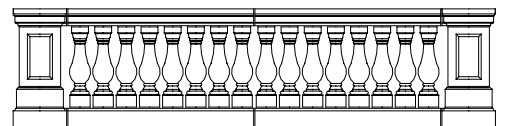
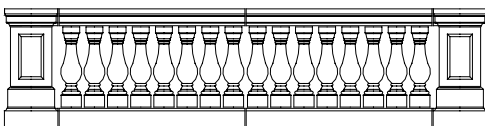



Balustrade Pier

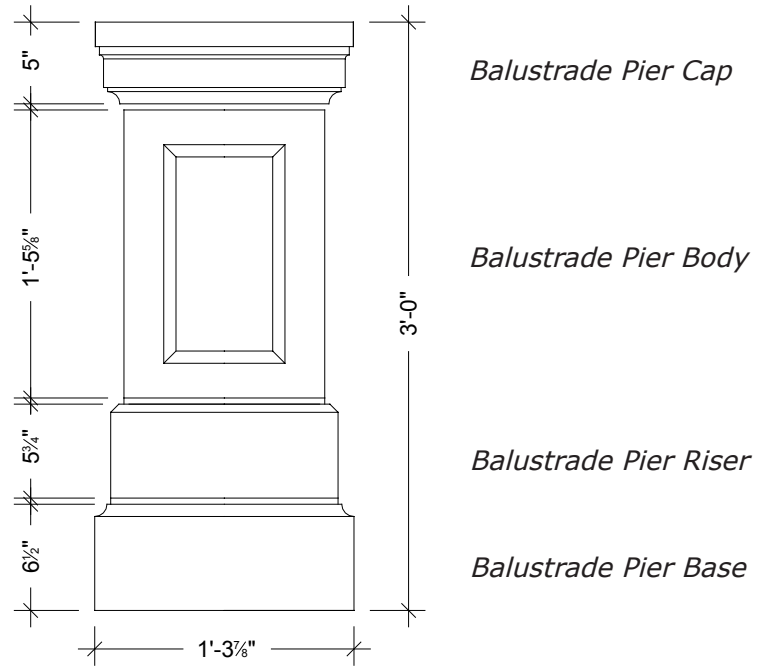

Starter Condition

Thru Condition

90 degree Condition

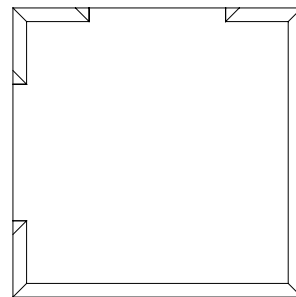
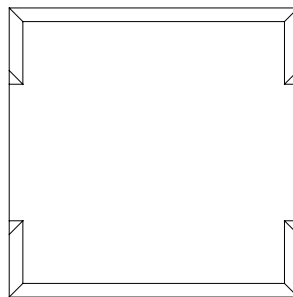
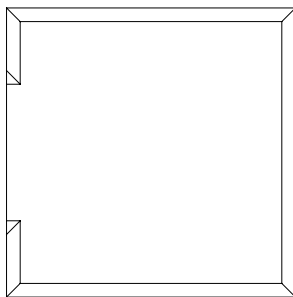

| | |
|---------|------------------------------|
| Item: | Balustrade Pier Starter Base |
| Part # | BPFS |
| Height: | 36" |
| Note: | Pier is in 4 pieces |

| | |
|---------|---------------------------|
| Item: | Balustrade Pier Thru Base |
| Part # | BPFT |
| Height: | 36" |
| Note: | Pier is in 4 pieces |

| | |
|---------|-------------------------|
| Item: | Balustrade Pier 90 Base |
| Part # | BPF90 |
| Height: | 36" |
| Note: | Pier is in 4 pieces |



Utility/Veneer Stone

| | |
|------------|----------------------|
| Item: | Echo Stone (utility) |
| Part # | E1 |
| Height: | 7-5/8" |
| Thickness: | 3-5/8" |
| Length: | 35-5/8" |



| | |
|------------|----------------------|
| Item: | Echo Stone (utility) |
| Part # | E2 |
| Height: | 7-5/8" |
| Thickness: | 3-5/8" |
| Length: | 23-5/8" |

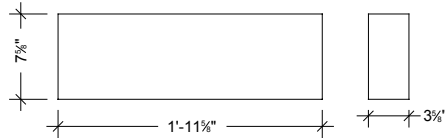

| | |
|------------|----------------------|
| Item: | Echo Stone (utility) |
| Part # | E3 |
| Height: | 7-5/8" |
| Thickness: | 3-5/8" |
| Length: | 15-5/8" |

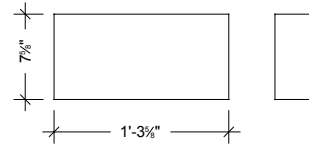

| | |
|------------|----------------------|
| Item: | Echo Stone (utility) |
| Part # | E4 |
| Height: | 7-5/8" |
| Thickness: | 3-5/8" |
| Length: | 7-5/8" |

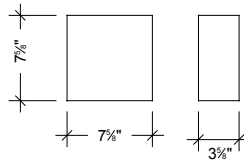

| | |
|------------|----------------------|
| Item: | Echo Stone (utility) |
| Part # | E5 |
| Height: | 3-5/8" |
| Thickness: | 3-5/8" |
| Length: | 23-5/8" |

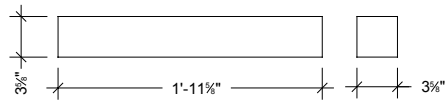

| | |
|------------|----------------------|
| Item: | Echo Stone (utility) |
| Part # | E6 |
| Height: | 23-5/8" |
| Thickness: | 3-5/8" |
| Length: | 23-5/8" |

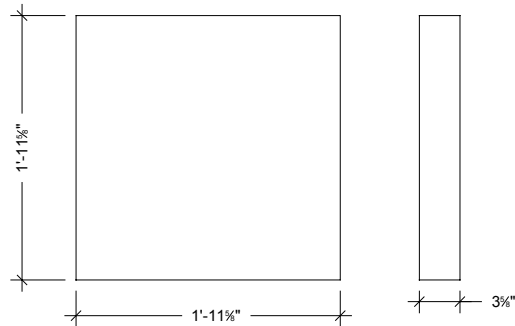

| | |
|------------|----------------------|
| Item: | Echo Stone (utility) |
| Part # | E7 |
| Height: | 15-5/8" |
| Thickness: | 3-5/8" |
| Length: | 15-5/8" |

